

END ELEVATION

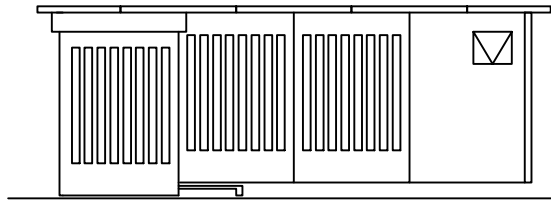

FRONT ELEVATION

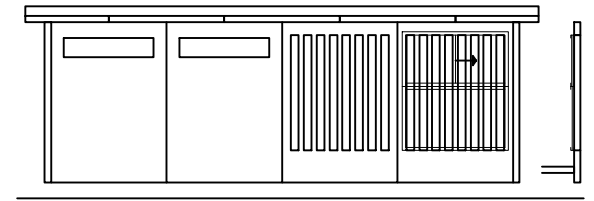

REAR ELEVATION

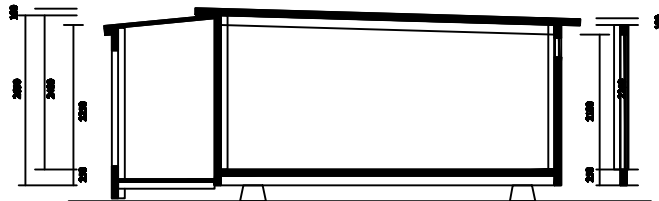

SECTION C

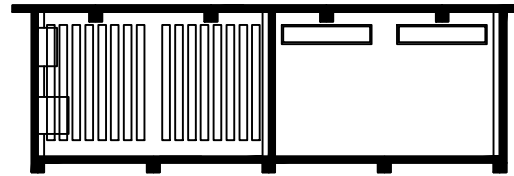

SECTION B

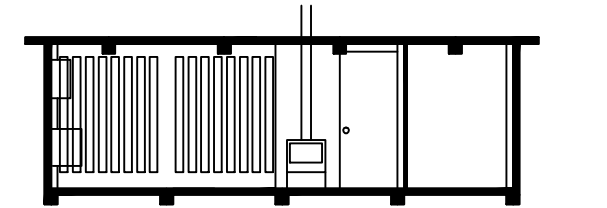

SECTION A

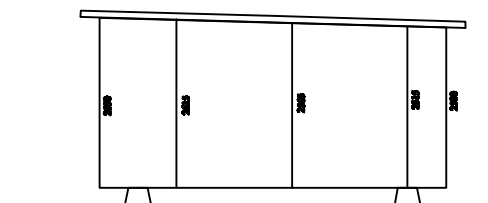

END ELEVATION

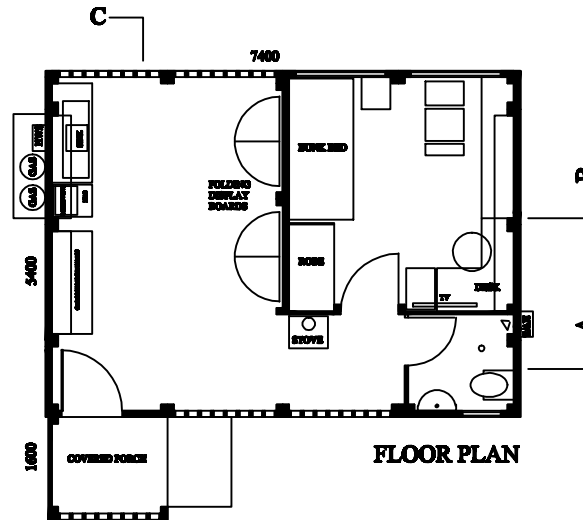

FLOOR PLAN

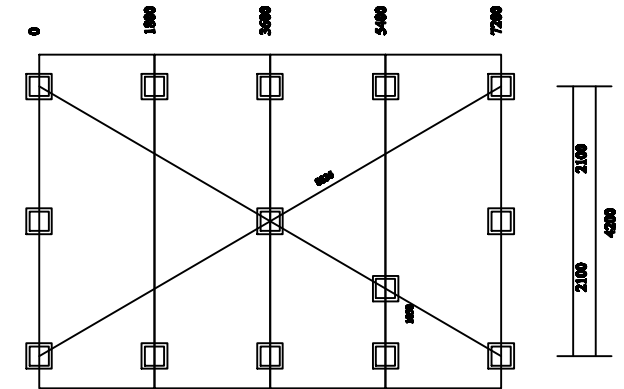

FOOTINGS PLAN