

ELEVATION 2

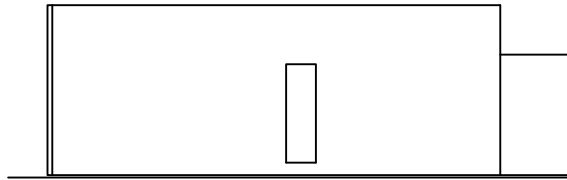

ELEVATION 4

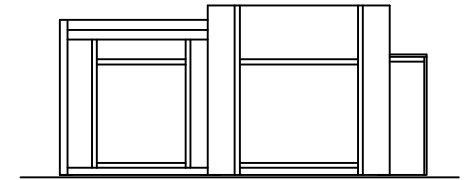

ELEVATION 3

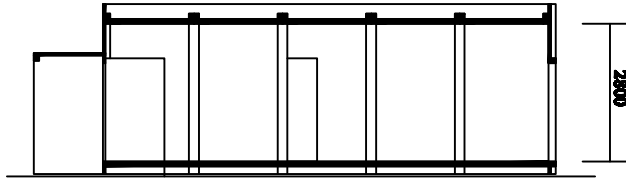

SECTION A

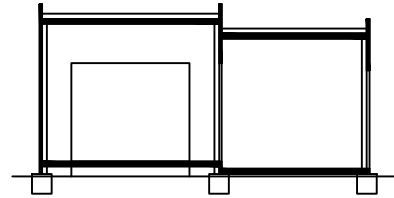

SECTION D

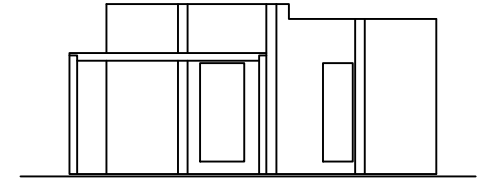

ELEVATION 1

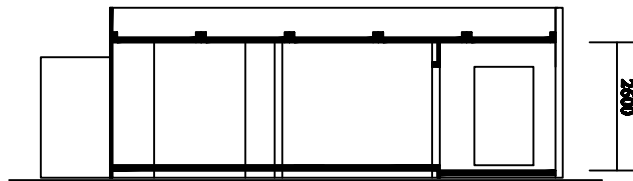

SECTION B

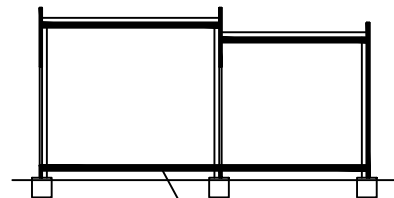

SECTION C

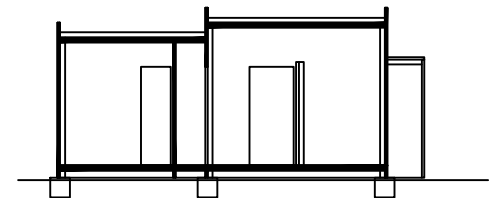

SECTION E

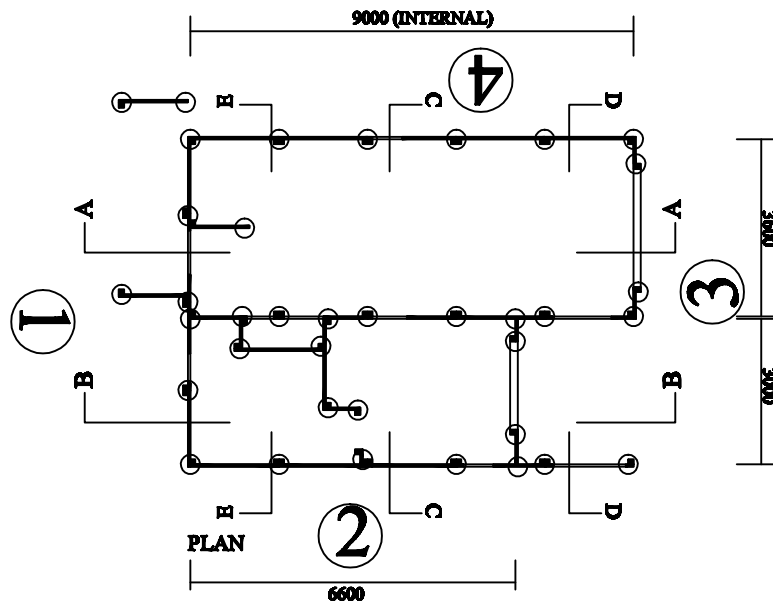

CONCRETE FLOOR SLAB SHOWN.
POURED AFTER LOCKUP
NOT REQUIRED FOR STRUCTURAL SHELL
CONSTRUCTION.

AREA HOUSE EXTERNAL = 54 SQM
 AREA REAR PORCH = 7 SQM
 AREA FRONT PORCH = 6 SQM

STRUCTURAL SHELL

9268

COPYRIGHT UNIBUILD
 UNIBUILD
 www.unibuild.com.au